

MUR460GER

4.0AMPS .GLASS PASSIVATED ULTRA FAST RECTIFIERS

FEATURE

- . Glass passivated chip
- . High current capability
- . Low forward voltage drop
- . High surge capability
- . Superfast recovery time for high efficiency
- . High temperature soldering guaranteed
260°C /1 0sec/0.375" lead length at 5 lbs tension

MECHANICAL DATA

- . Terminal: Plated axial leads solderable per MIL-STD 202E, method 208C
- . Case: Molded with UL-94 Class V-0 recognized Flame Retardant Epoxy (free halogen)
- . Polarity: color band denotes cathode
- . Weight: 1.0 grams
- . Mounting position: any

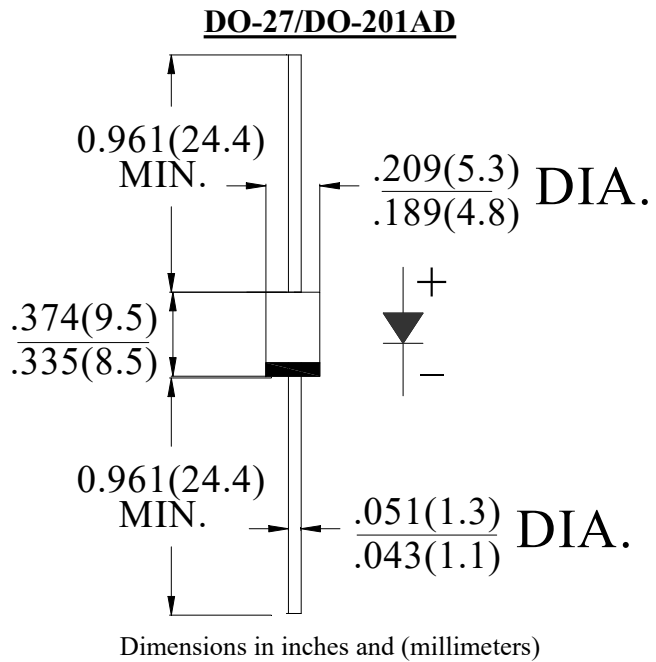

MAXIMUM RATINGS AND ELECTRICAL CHARACTERISTICS

Ratings at 25°C ambient temperature unless otherwise specified.

Single phase, half wave, 60Hz, resistive or inductive load. For capacitive load, derate current by 20%

Type Number	SYM BOL	MUR460GER	units
Maximum Recurrent Peak Reverse Voltage	V_{RRM}	600	V
Maximum RMS Voltage	V_{RMS}	420	V
Maximum DC blocking Voltage	V_{DC}	600	V
Maximum Average Forward Rectified Current .375"(9.5mm) lead length	$I_{F(AV)}$	4.0	A
Peak Forward Surge Current 8.3ms single half sine-wave superimposed on rated load (JEDEC method)	I_{FSM}	120.0	A
Maximum Forward Voltage at 4.0A DC	V_F	1.3	V
Maximum DC Reverse Current @ $T_J=25^\circ\text{C}$ at rated DC blocking voltage @ $T_J=125^\circ\text{C}$	I_R	5.0 200.0	μA
Maximum Reverse Recovery Time (Note 1)	t_{rr}	50	nS
Typical Junction Capacitance (Note 2)	C_J	50	pF
Typical Thermal Resistance (Note 3)	$R_{(JA)}$	40	$^\circ\text{C/W}$
	$R_{(JC)}$	10	
Storage Temperature	T_{STG}	-55 to +150	$^\circ\text{C}$
Operation Junction Temperature	T_J	-55 to +150	$^\circ\text{C}$

Note:

1. Reverse Recovery test Condition: $I_F=0.5\text{A}$, $I_R=1.0\text{A}$, $IRR=0.25\text{A}$;
2. Measured at 1.0 MHz and applied reverse voltage of 4.0Vdc
3. Thermal Resistance from Junction to Ambient at 0.375"(9.5mm)lead length,with leads attached to heat sink

RATING AND CHARACTERISTIC CURVES

FIG.1-TYPICAL FORWARD CURRENT DERATING CURVE

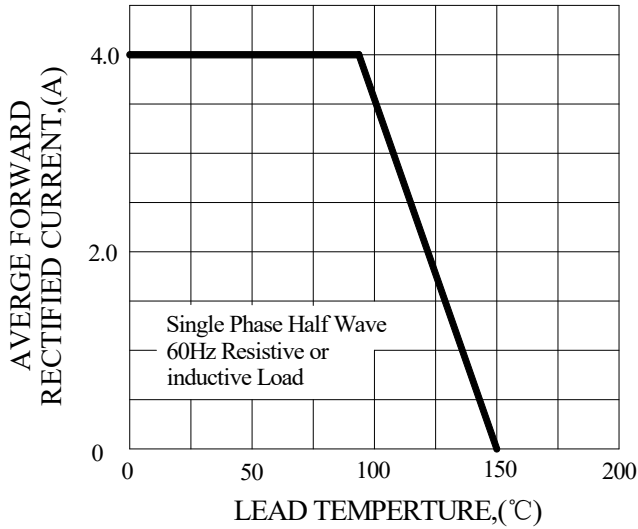

FIG.2-TYPICAL INSTANTANEOUS FORWARD CHARACTERISTICS

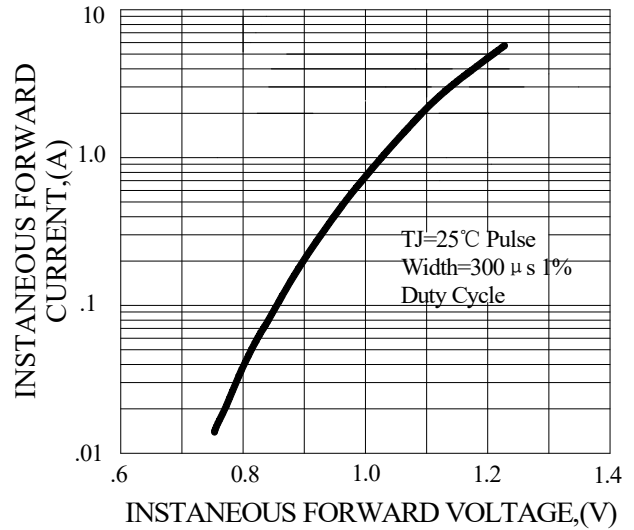

FIG.3-MAXIMUM NON-REPETITIVE FORWARD SURGE CURRENT

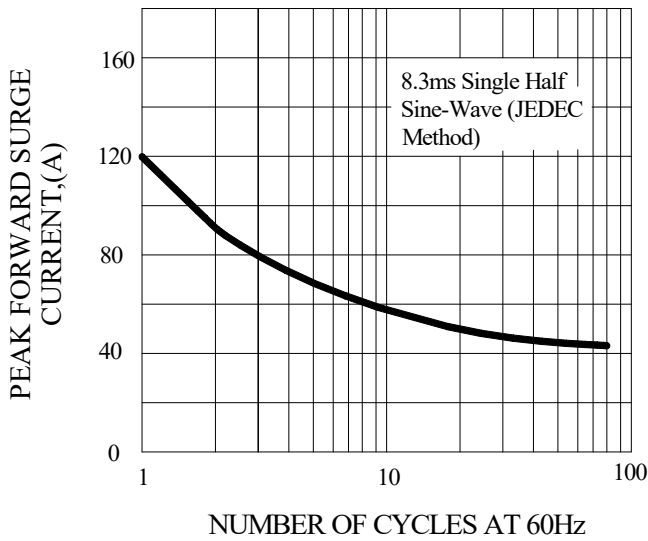

FIG.4-TYPICAL REVERSE CHARACTERISTICS

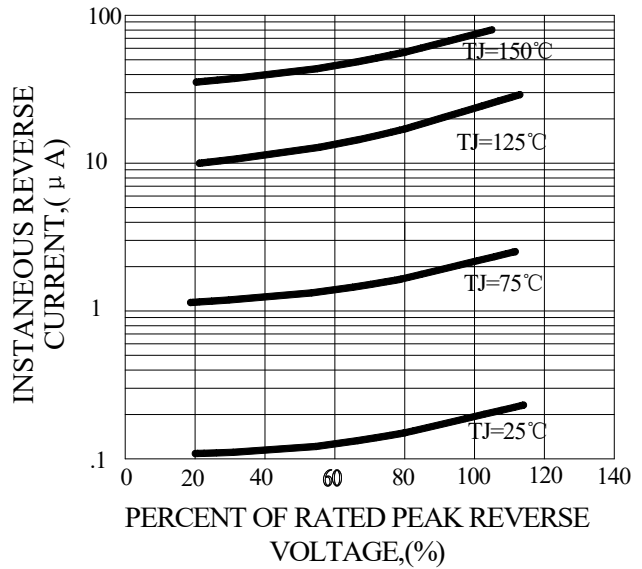
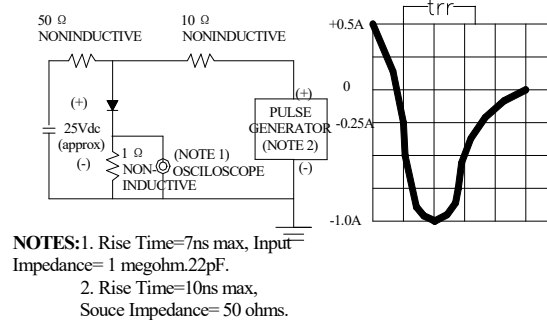
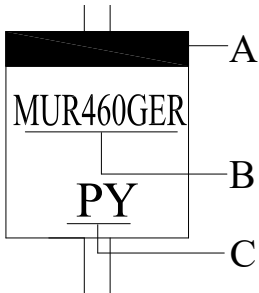

FIG.6-TEST CIRCUIT DIAGRAM AND REVERSE RECOVERY TIME CHARACTERISTIC



Marking and packaging illustration

1、Marking



SYMBOL	Explanation
A	Color Band Denotes Cathode
B	Product Name
C	Trademark

2、Packaging

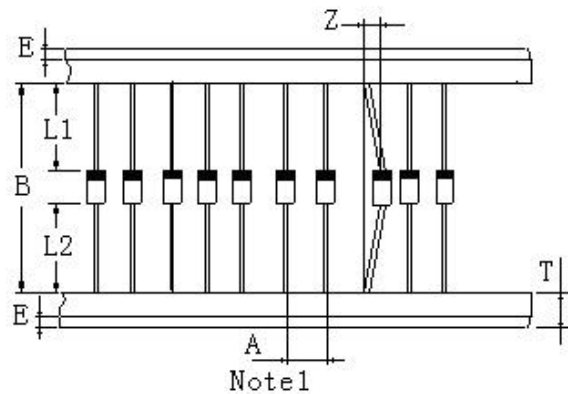

ITEM	SYMBOL	SPECIFICATIONS (mm)	SPECIFICATIONS (inch)
Component alignment	Z	1.2max	0.048max
Tape width	T	6.0±0.4	0.236±0.016
Exposed adhesive	E	0.8max	0.032max
Body eccentricity	L1-L2	1.0max	0.040max
Component	A	10.0±0.5	0.4±0.02
Inner tap	B	52.0~53.5	2.05~2.11

NOTE:

Each component lead shall be sandwiched between tapes for a minimum of 2.5mm (0.1inch)